

Chapter 29 – Electromagnetic Induction

- Induction Experiments
- Faraday's Law
- Lenz's Law
- Motional Electromotive Force
- Induced Electric Fields
- Eddy Currents
- Displacement Current and Maxwell's Equations
- Superconductivity

- If the **magnetic flux** through a circuit changes, an emf and a current are induced.
- A time-varying magnetic field can act as source of electric field. **Maxwell**
- A time-varying electric field can act as source of magnetic field.

1. Induction Experiments (Faraday / Henry)

- An **induced current** (and **emf**) is generated when: (a) we move a magnet around a coil, (b) move a second coil toward/away another coil, (c) change the current in the second coil by opening/closing a switch.

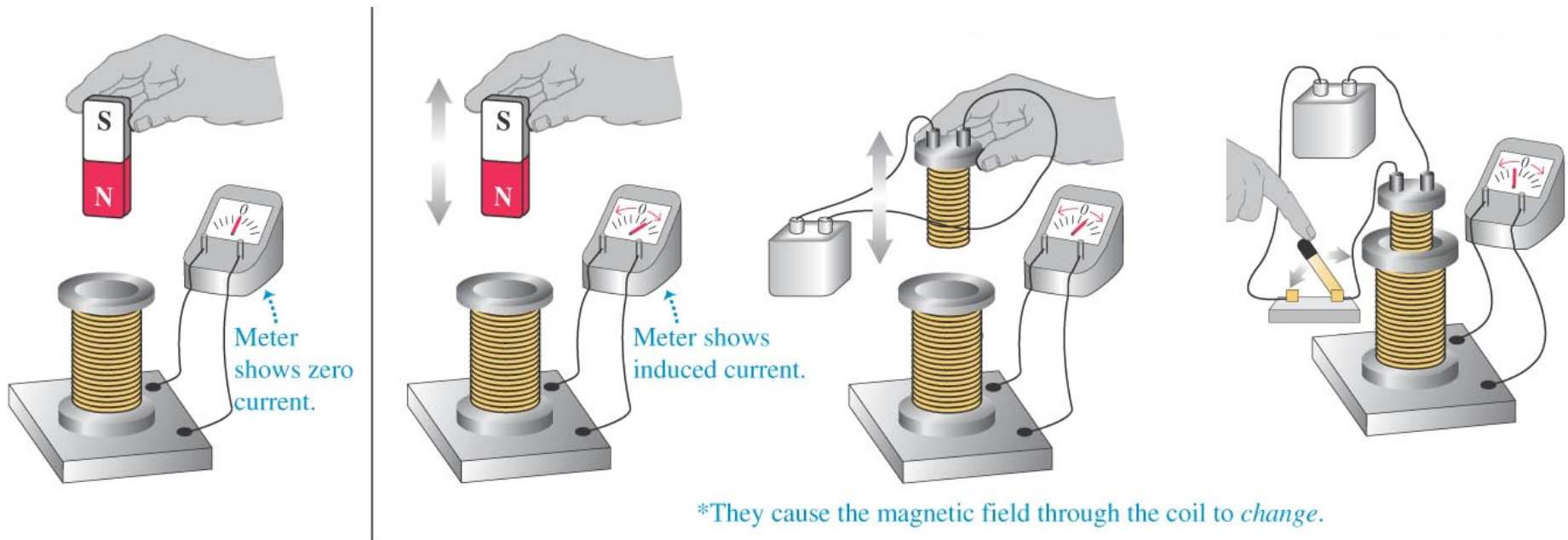

- Magnetically induced emfs are always the result of the action of \vec{E}_n (non-electrostatic forces. The electric fields caused by those forces are \vec{E}_n (non-Coulomb, non conservative).

2. Faraday's Law

Magnetic flux:

$$\Phi_B = \int \vec{B} \cdot d\vec{A} = \int B \cos \varphi \cdot dA$$

If \vec{B} is uniform over a flat area \vec{A} : $\Phi_B = \vec{B} \cdot \vec{A} = B \cdot A \cdot \cos \varphi$

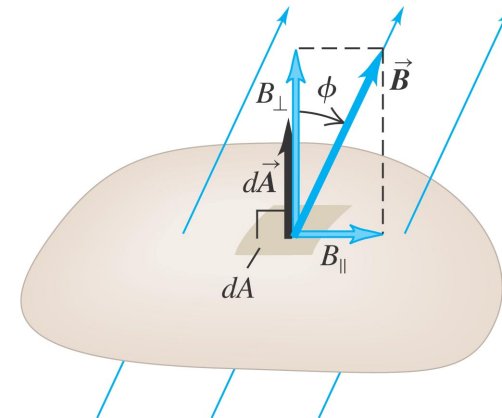

Surface is face-on to magnetic field:

- \vec{B} and \vec{A} are parallel (the angle between \vec{B} and \vec{A} is $\phi = 0$).
- The magnetic flux $\Phi_B = \vec{B} \cdot \vec{A} = BA$.

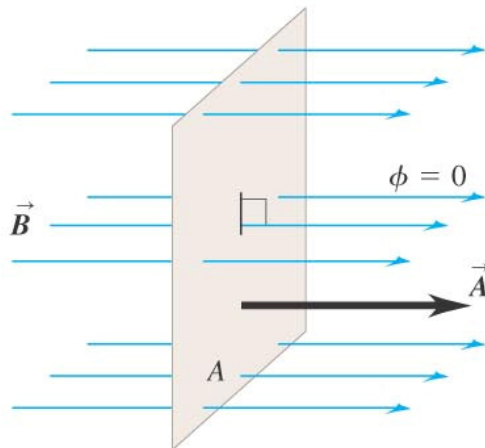

Surface is tilted from a face-on orientation by an angle ϕ :

- The angle between \vec{B} and \vec{A} is ϕ .
- The magnetic flux $\Phi_B = \vec{B} \cdot \vec{A} = BA \cos \phi$.

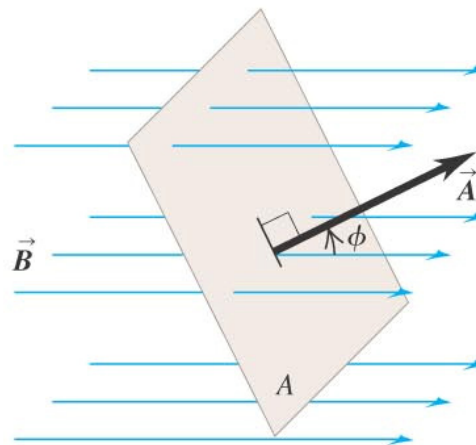

Surface is edge-on to magnetic field:

- \vec{B} and \vec{A} are perpendicular (the angle between \vec{B} and \vec{A} is $\phi = 90^\circ$).
- The magnetic flux $\Phi_B = \vec{B} \cdot \vec{A} = BA \cos 90^\circ = 0$.

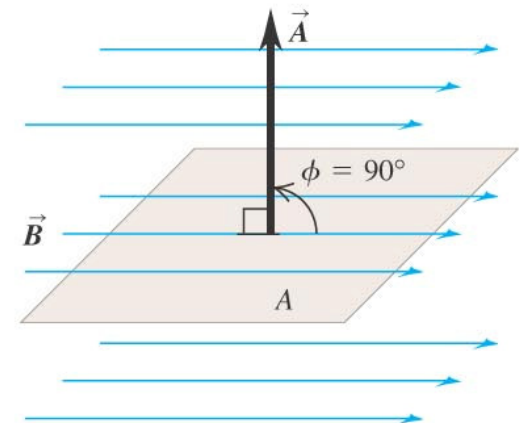

Faraday's Law of Induction:

- The induced emf in a closed loop equals the negative of the time rate of change of the magnetic flux through the loop.

$$\mathcal{E} = -\frac{d\Phi_B}{dt}$$

- Increasing flux $\rightarrow \mathcal{E} < 0$; Decreasing flux $\rightarrow \mathcal{E} > 0$

- Direction: curl fingers of right hand around \vec{A} , if $\mathcal{E} > 0$ is in same direction of fingers (counter-clockwise), if $\mathcal{E} < 0$ contrary direction (clockwise).

- Only a change in the flux through a circuit (not flux itself) can induce emf. If flux is constant \rightarrow no induced emf.

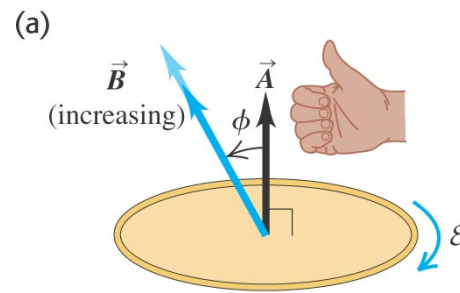

- Flux is positive ($\Phi_B > 0$) ...
- ... and becoming more positive ($d\Phi_B/dt > 0$).
- Induced emf is negative ($\mathcal{E} < 0$).

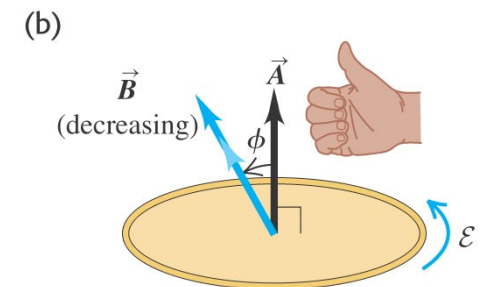

- Flux is positive ($\Phi_B > 0$) ...
- ... and becoming less positive ($d\Phi_B/dt < 0$).
- Induced emf is positive ($\mathcal{E} > 0$).

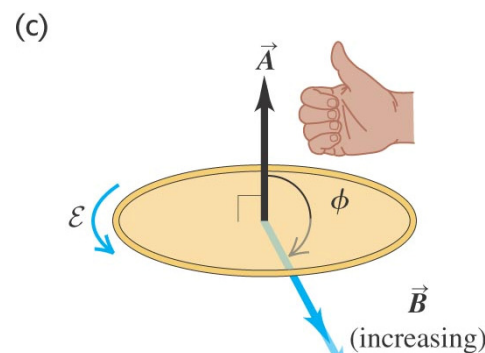

- Flux is negative ($\Phi_B < 0$) ...
- ... and becoming more negative ($d\Phi_B/dt < 0$).
- Induced emf is positive ($\mathcal{E} > 0$).

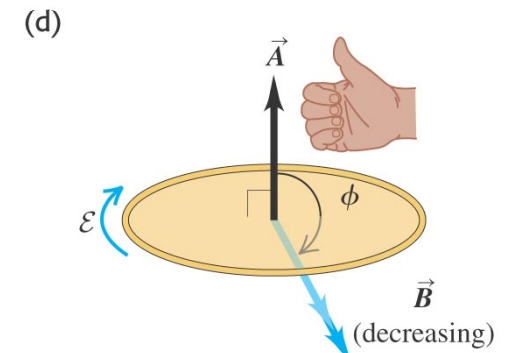

- Flux is negative ($\Phi_B < 0$) ...
- ... and becoming less negative ($d\Phi_B/dt > 0$).
- Induced emf is negative ($\mathcal{E} < 0$).

Coil:

$$\mathcal{E} = -N \frac{d\Phi_B}{dt}$$

N = number of turns

- If the loop is a conductor, an induced current results from emf. This current produces an additional magnetic field through loop. From right hand rule, that field is opposite in direction to the increasing field produced by electromagnet.

Ex: 29.4 - Generator I: a simple alternator

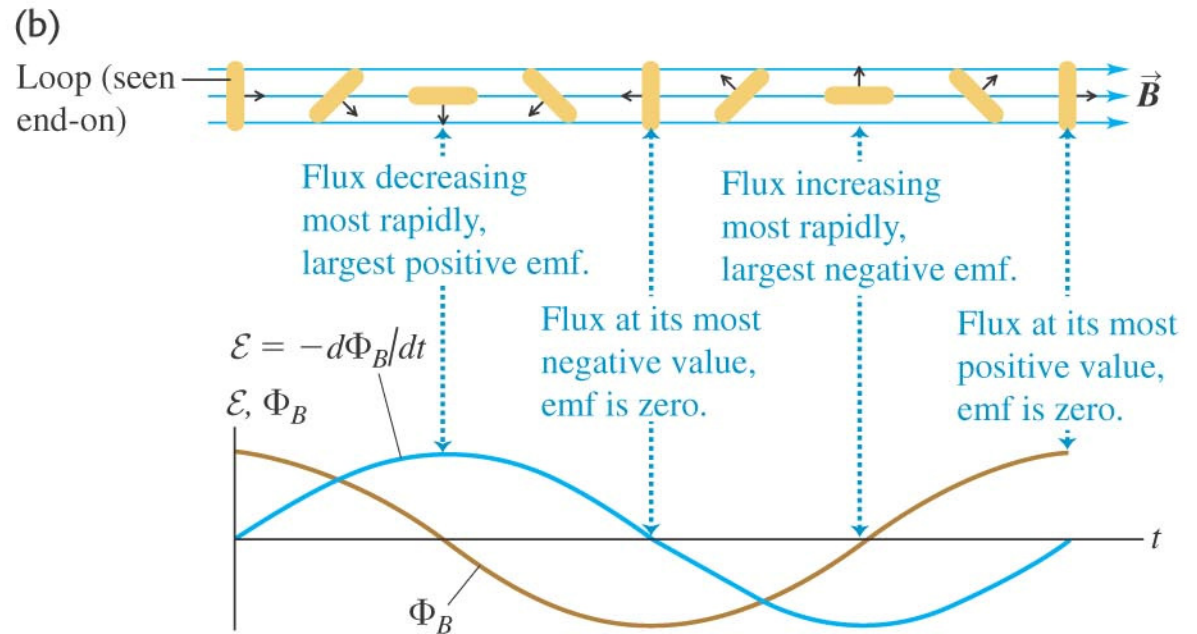
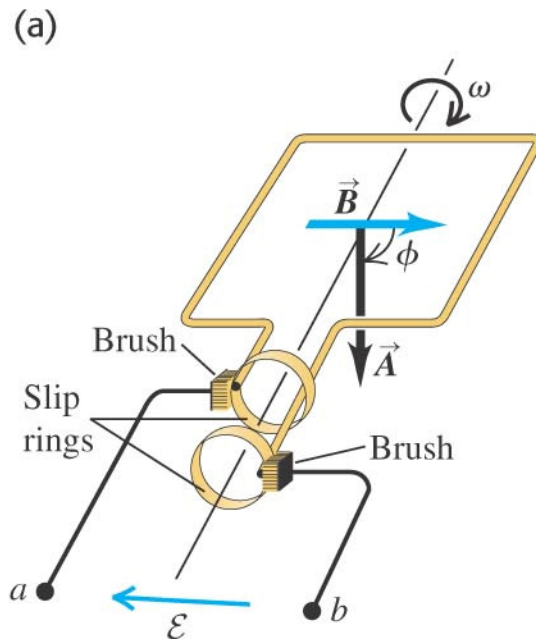

Exs: 29.6, 29.7 - Generator III: the slide wire generator

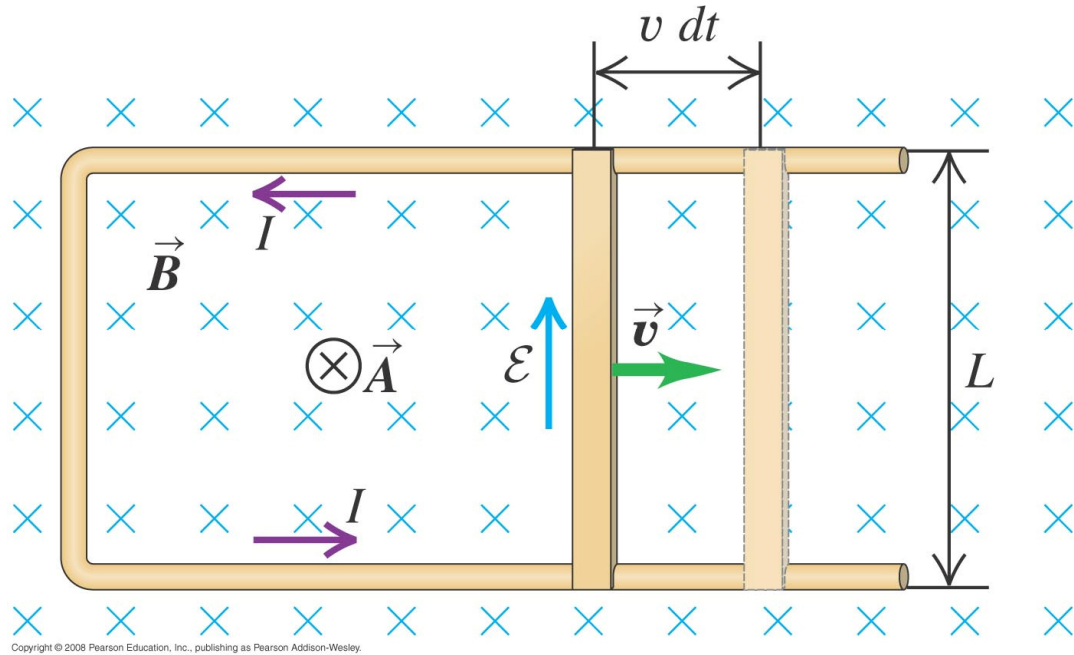

Copyright © 2008 Pearson Education, Inc., publishing as Pearson Addison-Wesley

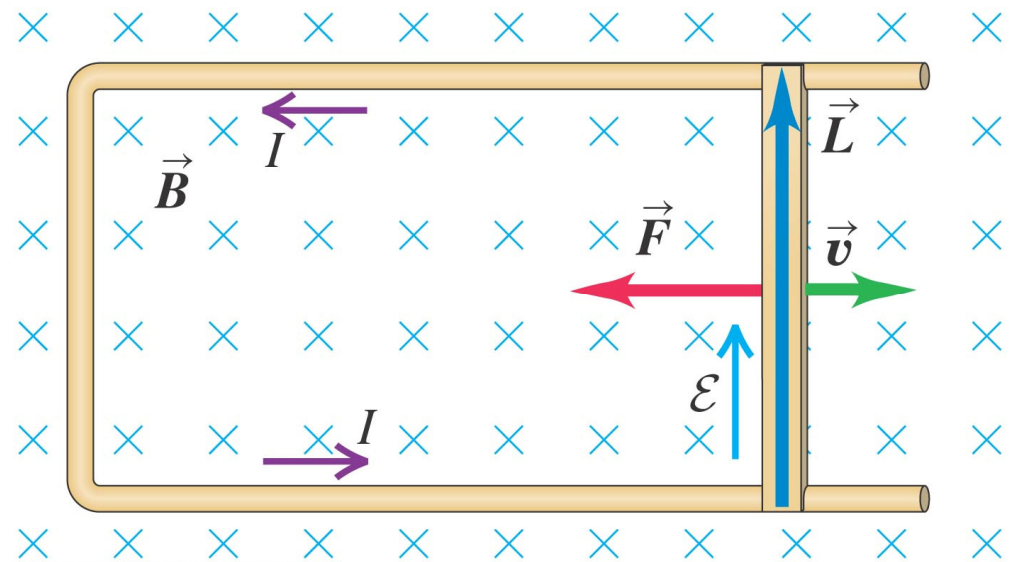

Copyright © 2008 Pearson Education, Inc., publishing as Pearson Addison-Wesley

3. Lenz's Law

- Alternative method for determining the direction of induced current or emf.

The direction of any magnetic induction effect is such as to oppose the cause of the effect.

-The “cause” can be changing the flux through a stationary circuit due to varying B, changing flux due to motion of conductors, or both.

(a) Motion of magnet causes increasing downward flux through loop.

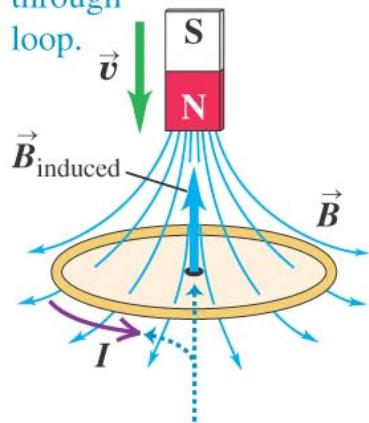

The induced magnetic field is *upward* to oppose the flux change. To produce this induced field, the induced current must be *counterclockwise* as seen from above the loop.

(b) Motion of magnet causes decreasing upward flux through loop.

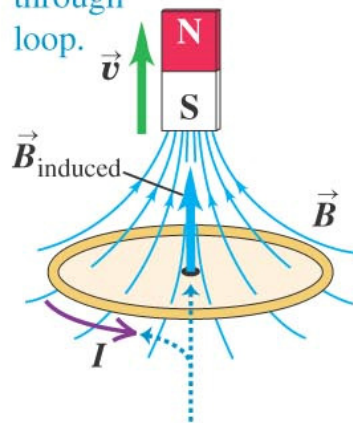

(c) Motion of magnet causes decreasing downward flux through loop.

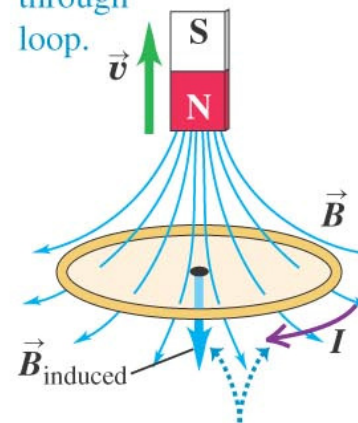

The induced magnetic field is *downward* to oppose the flux change. To produce this induced field, the induced current must be *clockwise* as seen from above the loop.

(d) Motion of magnet causes increasing upward flux through loop.

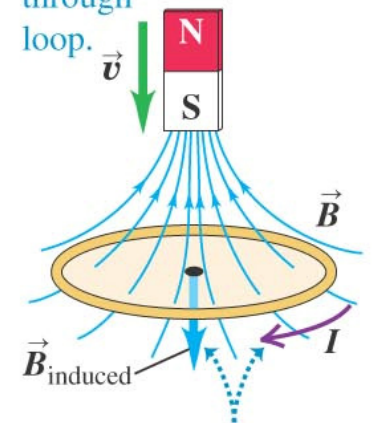

- If the flux in an stationary circuit changes, the induced current sets up a magnetic field *opposite* to the original field if original B *increases*, but in the *same direction* as original B if B *decreases*.
- The induced current opposes the change in the flux through a circuit (not the flux itself).
- If the change in flux is due to the motion of a conductor, the direction of the induced current in the moving conductor is such that the direction of the magnetic force on the conductor is opposite in direction to its motion (e.g. slide-wire generator). The induced current tries to preserve the “status quo” by opposing motion or a change of flux.

B induced downward opposing the change in flux ($d\Phi/dt$). This leads to induced current clockwise.

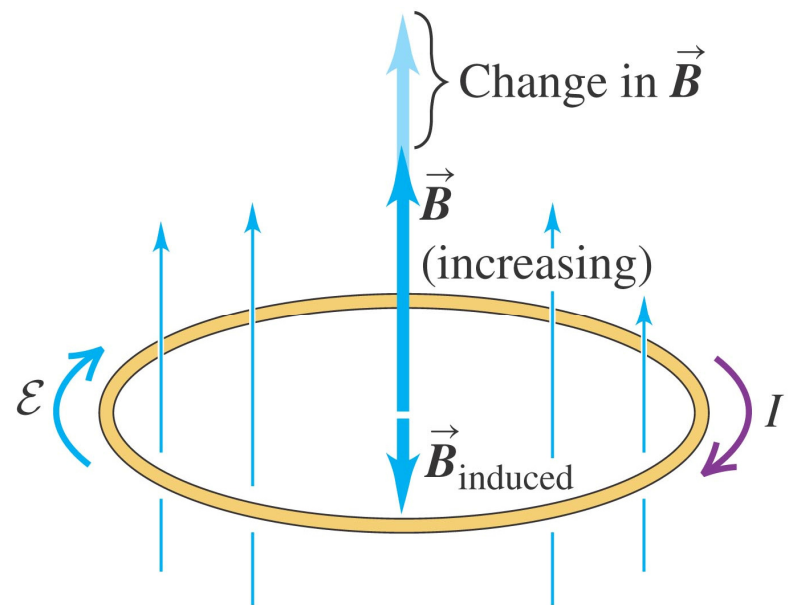

Lenz's Law and the Response to Flux Changes

- Lenz's Law gives only the *direction* of an induced current. The *magnitude* depends on the circuit's resistance. Large $R \rightarrow$ small induced $I \rightarrow$ easier to change flux through circuit.
- If loop is a good conductor \rightarrow I induced present as long as magnet moves with respect to loop. When relative motion stops $\rightarrow I = 0$ quickly (due to circuit's resistance).
- If $R = 0$ (superconductor) \rightarrow I induced (*persistent current*) flows even after induced emf has disappeared (after magnet stopped moving relative to loop). The flux through loop is the same as before the magnet started to move \rightarrow flux through loop of $R = 0$ does not change.

Magnetic levitation:

-The principle of levitation is Lenz' rule.

- 1) The magnetic field created by the induced current in a metallic sample due to time-fluctuation of the external magnetic field of the coil wants to avoid its cause (i.e., the coil's fluctuating magnetic field).
- 2) Thus, the induced magnetic field in the sample and the external fluctuating magnetic field of the coil repel each other.
- 3) The induced magnetic field (and the sample) move away from its cause, i.e. away from the coil's magnetic field. Then, for a conical coil (smaller radius at the bottom than at the top) the metallic sample will move upward due to this levitation force, until the force of gravity balances the force of levitation. (The levitation force is larger at the bottom of the conical coil than at the top of the coil).

Induced Current / Eddy current levitation:

- The rail and the train exert magnetic fields and the train is levitated by repulsive forces between these magnetic fields.
- B in the train is created by electromagnets or permanent magnets, while the repulsive force in the track is created by a induced magnetic field in conductors within the tracks.
- Problems:
 - (1) at slow speeds the current induced in the coils of the track's conductors and resultant magnetic flux is not large enough to support the weight of the train. Due to this, the train needs wheels (or any landing gear) to support itself until it reaches a speed that can sustain levitation.
 - (2) this repulsive system creates a field in the track (in front and behind the lift magnets) which act against the magnets and creates a "drag force". This is normally only a problem at low speed.



4. Motional Electromotive Force

- A charged particle in rod experiences a magnetic force $\vec{F} = q\vec{v} \times \vec{B}$ that causes free charges in rod to move, creating excess charges at opposite ends.

- The excess charges generate an electric field (from a to b) and electric force ($F = qE$) opposite to magnetic force.

- Charge continues accumulating until F_E compensates F_B and charges are in equilibrium $\rightarrow qE = qvB$

$$V_{ab} = E \cdot L = v \cdot B \cdot L$$

- If rod slides along stationary U-shaped conductor \rightarrow no F_B acts on charges in U-shaped conductor, but excess charge at ends of straight rod redistributes along U-conductor, creating an electric field.

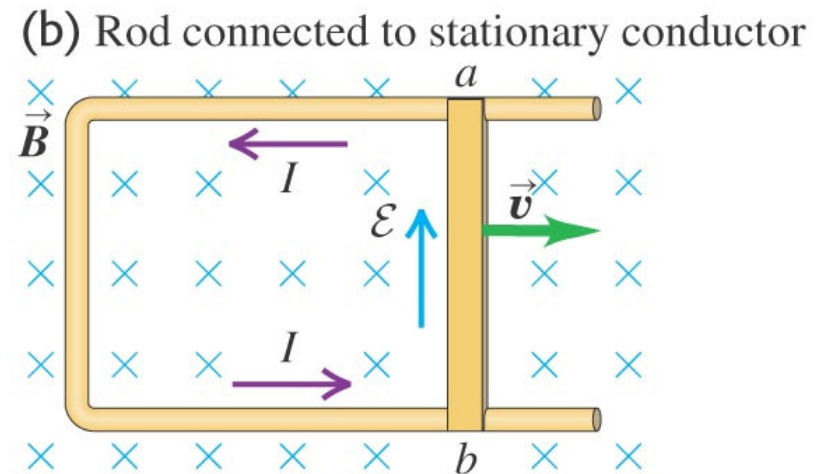
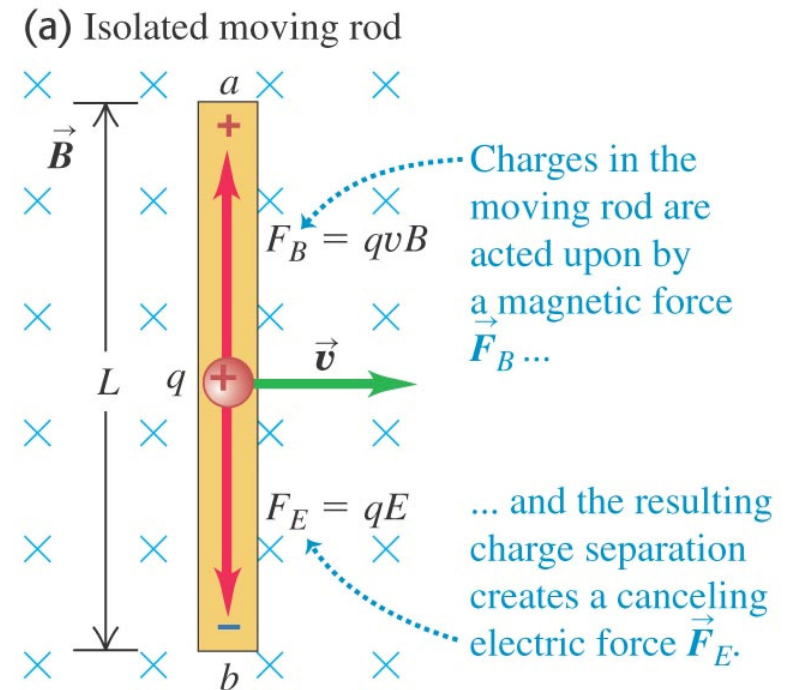

The motional emf \mathcal{E} in the moving rod creates an electric field in the stationary conductor.

-The electric field in stationary U-shaped conductor creates a current → moving rod became a source of emf (**motional electromotive force**). Within straight rod charges move from lower to higher potential, and in the rest of circuit from higher to lower potential.

$$\mathcal{E} = vBL \quad \text{Length of rod and velocity perpendicular to } \vec{B}.$$

Induced current:
$$I = \frac{\mathcal{E}}{R} = \frac{vBL}{R}$$

- The emf associated with the moving rod is equivalent to that of a battery with positive terminal at a and negative at b .

Motional emf: general form (alternative expression of Faraday's law)

$$d\mathcal{E} = (\vec{v} \times \vec{B}) \cdot d\vec{l}$$

$$\mathcal{E} = \oint (\vec{v} \times \vec{B}) \cdot d\vec{l}$$

Closed conducting loop

-This expression can only be used for problems involving moving conductors. When we have stationary conductors in changing magnetic fields, we need to use: $\mathcal{E} = -d\Phi_B/dt$.

5. Induced Electric Fields

- An induced emf occurs when there is a changing magnetic flux through a stationary conductor.
- A current (I) in solenoid sets up B along its axis, the magnetic flux is:

$$\Phi_B = B \cdot A = \mu_0 n I A$$

$$\mathcal{E} = -\frac{d\Phi_B}{dt} = -\mu_0 n A \frac{dI}{dt}$$

Induced current in loop (I'): $I' = \mathcal{E} / R$

- The force that makes the charges move around the loop is not a magnetic force. There is an **induced electric field** in the conductor caused by a changing magnetic flux.

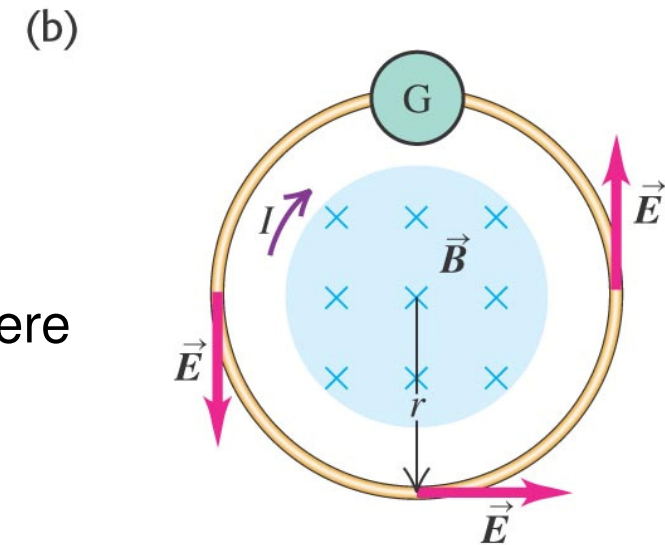
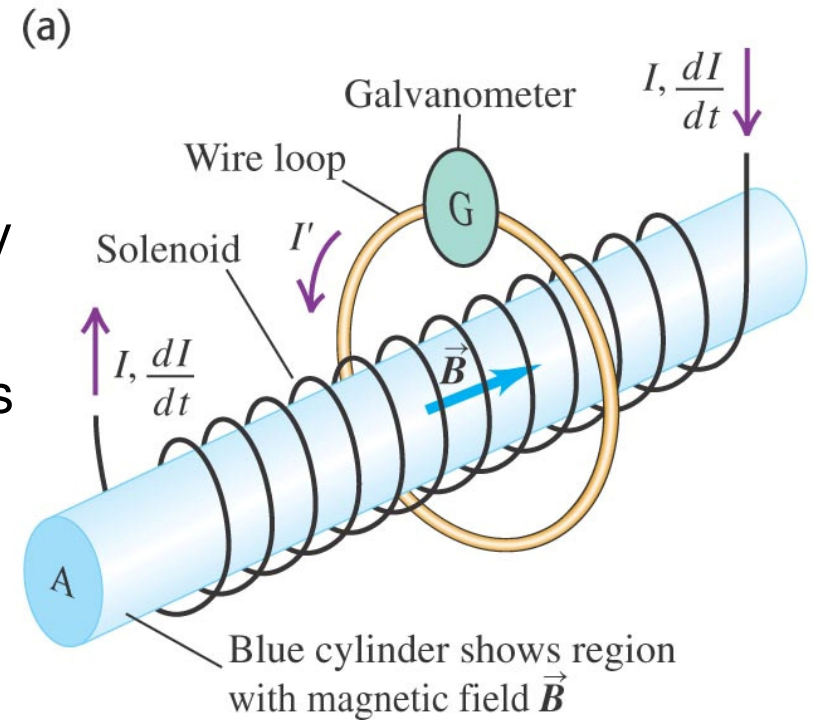

-The total work done on q by the induced \vec{E} when it goes once around the loop: $W = q \varepsilon \rightarrow \vec{E}$ is not conservative.

Conservative $\vec{E} \rightarrow \oint \vec{E} \cdot d\vec{l} = 0$

Non-conservative $\vec{E} \rightarrow \oint \vec{E} \cdot d\vec{l} = \varepsilon = -\frac{d\Phi_B}{dt}$ (stationary integration path)

- Cylindrical symmetry $\rightarrow \vec{E}$ magnitude constant, direction is tangent to loop.

$$\oint \vec{E} \cdot d\vec{l} = 2\pi \cdot r \cdot E \longrightarrow E = \frac{1}{2\pi r} \left| \frac{d\Phi_B}{dt} \right|$$

- **Faraday's law:** 1) an emf is induced by magnetic forces on charges when a conductor moves through \vec{B} .

2) a time-varying \vec{B} induces \vec{E} in stationary conductor and emf. \vec{E} is induced even when there is no conductor. Induced \vec{E} is non-conservative, "non-electrostatic". No potential energy associated, but $\vec{F}_E = q \vec{E}$.

6. Eddy Currents

- Induced currents that circulate throughout the volume of a material.

Ex.: \vec{B} confined to a small region of rotating disk \rightarrow Ob moves across \vec{B} and emf is induced \rightarrow induced circulation of eddy currents.

Sectors Oa and Oc are not in \vec{B} , but provide return conducting paths for charges displaced along Ob to return from b to O.

Induced I experiences \vec{F}_B that opposes disk rotation:

$$\vec{F} = I\vec{L} \times \vec{B} \quad (\text{right}) \rightarrow \text{current and } \vec{L} \text{ downward.}$$

(the return currents lie outside $\vec{B} \rightarrow$ do not experience F_B).

-The interaction between eddy currents and \vec{B} causes braking of disk.

(a) Metal disk rotating through a magnetic field

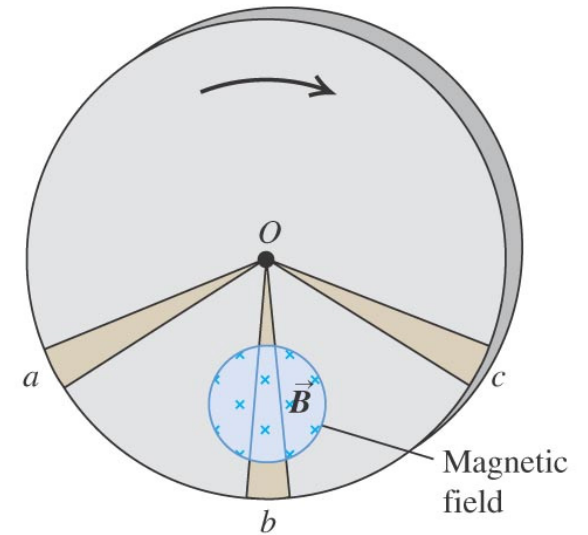

(b) Resulting eddy currents and braking force

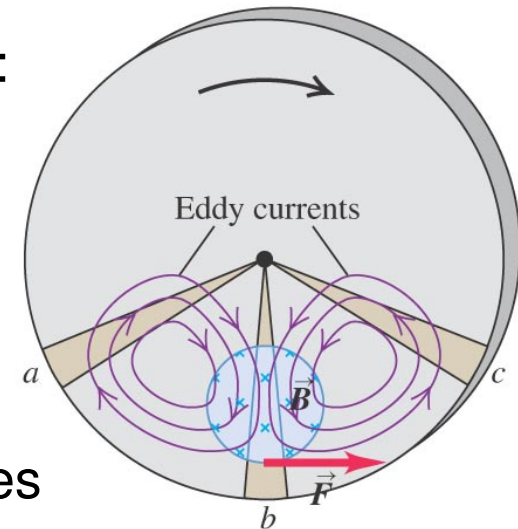

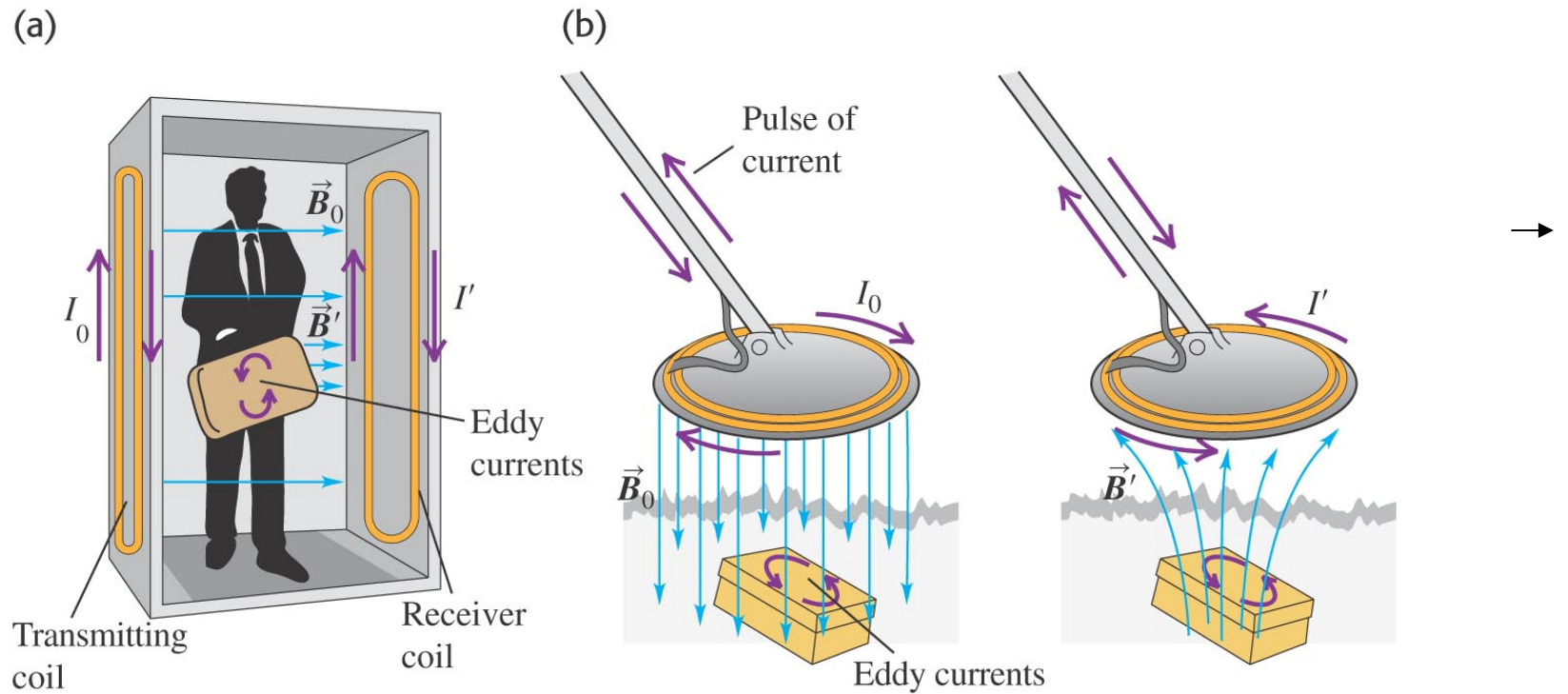

(a) Metal detector (airport security checkpoint) generates an alternating \vec{B}_0 that induces eddy currents in conducting object (suitcase). These currents produce alternating \vec{B}' that induces current in detector's receiver (I').

(b) Same principle as (a).

7. Displacement Current and Maxwell's Equations

- A varying electric field gives rise to a magnetic field.

Ampere's Law $\oint \vec{B} \cdot d\vec{l} = \mu_0 I_{encl}$ (incomplete)

Charging a capacitor: conducting wires carry i_C (*conduction current*) into one plate and out of the other, Q and E between plates increase.

$$\oint \vec{B} \cdot d\vec{l} = \mu_0 i_C \quad \text{but also} = 0 \text{ for surface bulging out}$$

Contradiction?

As capacitor charges, E and Φ_E through surface increase.

$$q = C \cdot v = \left(\frac{\epsilon \cdot A}{d} \right) (E \cdot d) = \epsilon \cdot E \cdot A = \epsilon \cdot \Phi_E$$

$$i_C = \frac{dq}{dt} = \epsilon \frac{d\Phi_E}{dt}$$

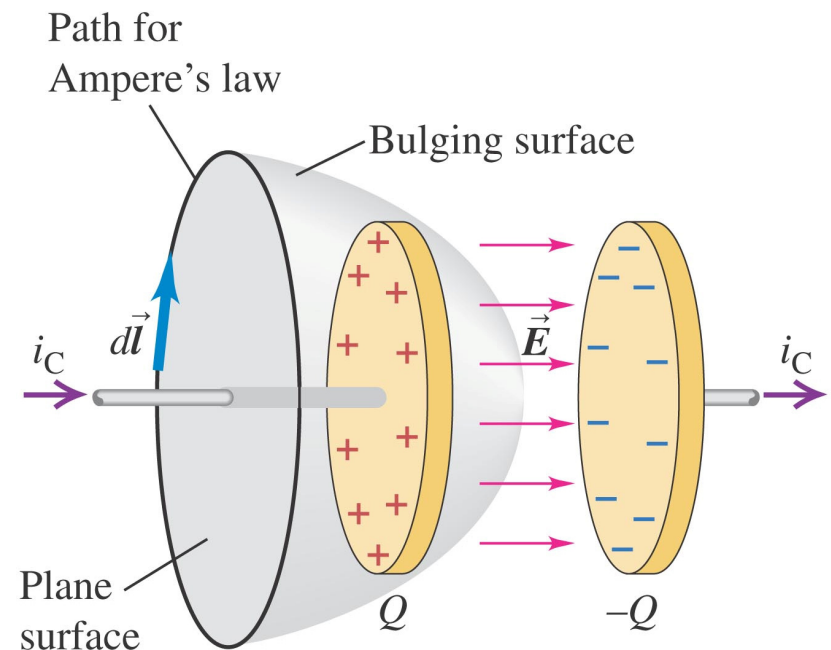

Displacement current (i_D): fictitious current in region between capacitor's plates.

$$i_D = \epsilon \frac{d\Phi_E}{dt}$$

Changing the flux through curved surface is equivalent in Ampere's law to a conduction current through that surface (i_D)

Generalized Ampere's Law: $\oint \vec{B} \cdot d\vec{l} = \mu_0 (I_C + I_D)_{encl}$

Valid for any surface we use: for curved surface $i_c = 0$, for flat surface $i_D = 0$.
 i_c (flat surface) = i_D (curved surface)

Displacement current density (j_D):

$$j_D = \frac{i_D}{A} = \epsilon \frac{dE}{dt}$$

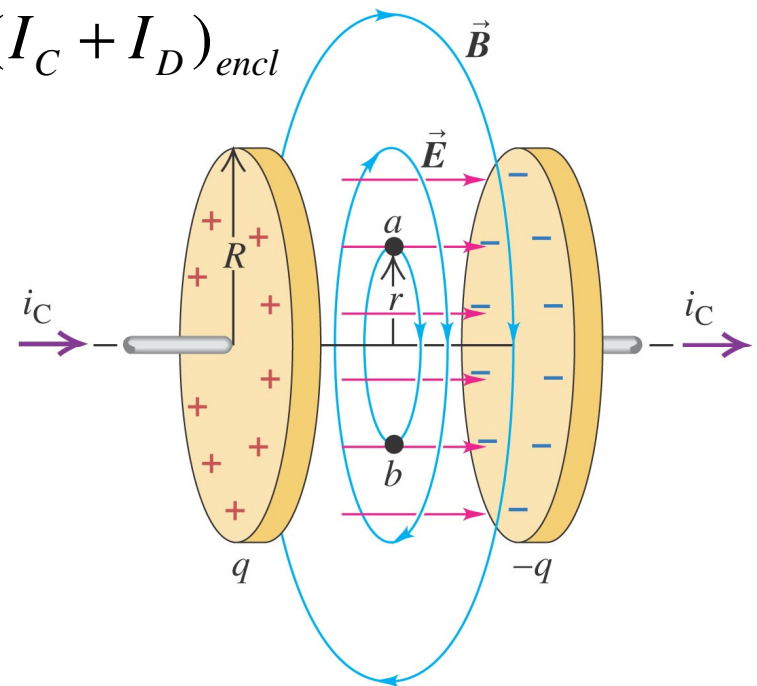

The displacement current is the source of B in between capacitor's plates. It helps us to satisfy Kirchoff's junction's rule: I_C in and I_D out

The reality of Displacement Current

- Displacement current creates B between plates of capacitor while it charges.

$$(r < R)$$

$$\oint \vec{B} \cdot d\vec{l} = 2\pi \cdot r \cdot B = \mu_0 I_{encl} = \mu_0 j_D A$$

$$= \mu_0 \left(\frac{i_D}{\pi \cdot R^2} \right) (\pi \cdot r^2) = \mu_0 \frac{r^2}{R^2} i_D = \mu_0 \frac{r^2}{R^2} i_C$$

$$B = \frac{\mu_0}{2\pi} \frac{r}{R^2} i_C$$

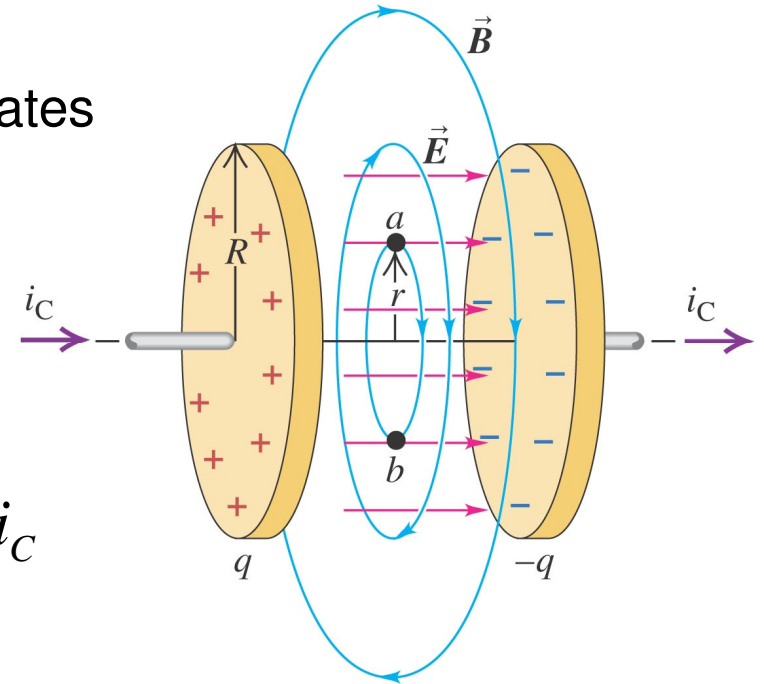

- In between the plates of the capacitor: $(r < R) \rightarrow B = 0$ at $r = 0$ (axis) and increases linearly with distance from axis.
- For $r > R \rightarrow B$ is same as though the wire were continuous and plates not present.

Maxwell's Equations of Electromagnetism

$$\oint \vec{E} \cdot d\vec{A} = \frac{Q_{encl}}{\epsilon_0}$$

Gauss Law for \vec{E}

$$\oint \vec{B} \cdot d\vec{A} = 0$$

Gauss Law for \vec{B} (there are no magnetic monopoles)

$$\oint \vec{B} \cdot d\vec{l} = \mu_0 \left(i_C + \epsilon_0 \frac{d\Phi_E}{dt} \right)_{encl}$$

Ampere's law

$$\oint \vec{E} \cdot d\vec{l} = -\frac{d\Phi_B}{dt}$$

Faraday's law

$$\vec{E} = \vec{E}_c + \vec{E}_n$$

Total electric field = E caused by a distribution of charges at rest (E_c = electrostatic) + E magnetically induced (E_n , non-electrostatic).

Symmetry in Maxwell's Equations

In empty space $i_c = 0$, $Q_{\text{encl}} = 0$

$$\Phi_E = \int \vec{E} \cdot d\vec{A}$$

$$\Phi_B = \int \vec{B} \cdot d\vec{A}$$

$$\oint \vec{B} \cdot d\vec{l} = \epsilon_0 \mu_0 \frac{d}{dt} \int \vec{E} \cdot d\vec{A}$$

$$\oint \vec{E} \cdot d\vec{l} = -\frac{d}{dt} \int \vec{B} \cdot d\vec{A}$$

$$\vec{F} = q(\vec{E} + \vec{v} \times \vec{B})$$

8. Superconductivity

- Sudden disappearance of R when material cooled below critical T (T_c).
- For superconducting materials T_c changes when material under external B_0 .

- With increasing B_0 , superconducting transition occurs at lower and lower T.

- Critical field (B_c): minimum B required to eliminate SC at $T < T_c$.

The Meissner effect

- SC sphere in B_0 at $T > T_c \rightarrow$ normal phase (not SC)
- If $T < T_c$ and B_0 not large enough to prevent SC transition \rightarrow distortion of field lines, no lines inside material.

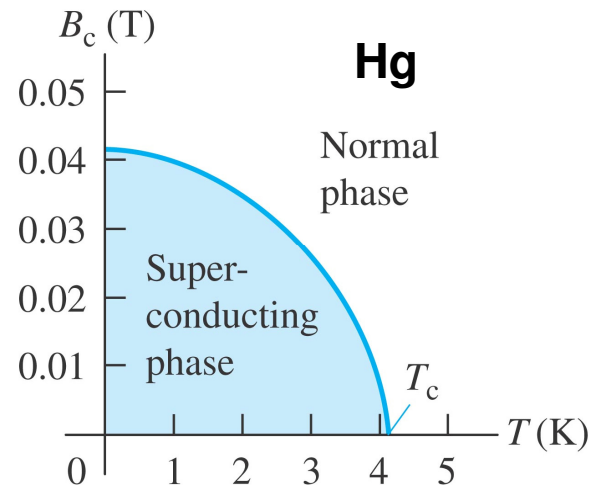

(a) Superconducting material in an external magnetic field \vec{B}_0 at $T > T_c$.

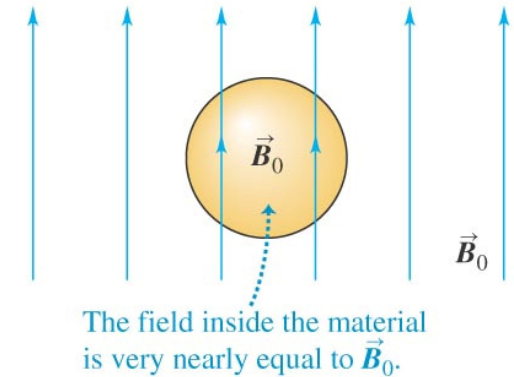

(b) The temperature is lowered to $T < T_c$, so the material becomes superconducting.

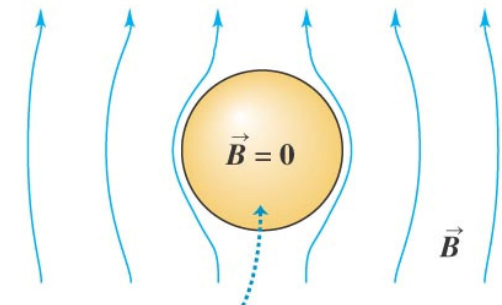

Magnetic flux is expelled from the material, and the field inside it is zero (Meissner effect).

(c) When the external field is turned off at $T < T_c$, the field is zero everywhere.

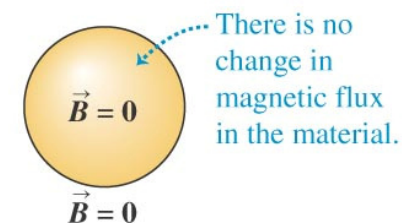

- If coil wrapped around sphere \rightarrow emf induced in coil shows that during SC transition the magnetic flux through coil decreases (to zero).
- If B_0 turned off while material still in SC phase \rightarrow no emf induced in coil and no B outside sphere.
- During SC transition in the presence of B_0 , all magnetic flux is expelled from the bulk of the sphere and the magnetic flux through a coil is zero. The “expulsion” of B is the “Meissner effect”. That results in an increased B (more densely packed field lines) close to the sides of the sphere.

<http://www.youtube.com/watch?v=G3eI4SVDyME>

(11:11) Emf Induction while moving a bar magnet over a conducting loop

<http://www.youtube.com/watch?v=qxuGDEz8wDg&NR=1>

(10:35), (17:10)

Emf induction while changing the angle ϕ in a loop

(38:28) Eddy currents